

482

SONIC MAXIMIZER

*User Guide
and
Reference
Manual*



BBE[®]
Sound Inc.

Important Safeguards

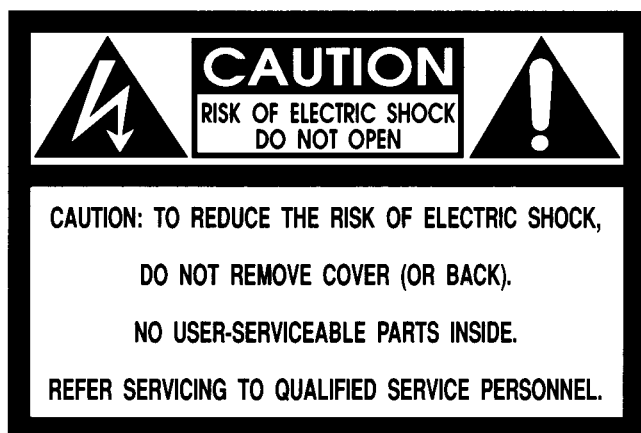

WARNING

To prevent fire or shock hazard, do not expose the unit to rain or moisture.

ATTENTION: RISQUE DE CHOC ELECTRIC- NE PAS OUVRIR.



The lightning flash with arrowhead symbol, within an equilateral triangle, is intended to alert the user to the presence of uninsulated "dangerous voltage" within the product's enclosure that may be of sufficient magnitude to constitute a risk of electric shock to persons.



The exclamation point, within a equilateral triangle is intended to alert the user to the presence of important operating and maintenance (servicing) instructions in the literature accompanying the appliance.

For your protection, please read these safety instructions completely before operating the appliance, and keep this manual for future reference.

Carefully observe all warnings, precautions and instructions on the appliance and described in the operating instructions supplied with the appliance.

INSTALLATION

Water and Moisture - Do not install the appliance near water: for example, near a bathtub, washbowl, kitchen sink, laundry tub, in a wet basement, or near a swimming pool.

Heat - Do not install the appliance near sources of heat such as radiators, heat registers, stoves, or other appliances that produce heat.

Ventilation - Situate the product so its location or position does not interfere with its proper ventilation. For example, you should not place the product on a bed, sofa, rug, or similar surface that might block the vent openings, or placed in a built-in installation, such as a bookcase or cabinet that might impede the flow of air through the ventilation openings.

Wall or Ceiling Mounting - If your appliance can be mounted to a wall or ceiling, mount it only as recommended.

USE

Power Source - Connect the appliance to a power supply only of the type described in the operating instructions or as marked on the appliance.

Power-Cord Protection - Route the power cord so that it is not likely to be walked on or pinched by having objects placed on it, paying particular attention to the plugs, receptacles, and the point where the cord exits from the appliance.

Grounding or Polarization - Do not defeat the grounding or polarization feature of the AC power cord. If your AC receptacle will not accept the power cord plug, contact your electrician to install a proper AC receptacle.

When not in use - Unplug the power cord of the appliance from the outlet when left unused for a long period of time. To disconnect the cord, pull it out by grasping the plug. Never pull the plug out by the cord.

AC Receptacle - Check to make sure that the AC receptacle holds the power cord plug firmly and securely. If the power cord plug is loose, contact your electrician to replace the defective and unsafe AC

Foreign Objects - Be careful that foreign objects and liquids do not enter the enclosure through openings.

SERVICE

Unplug the appliance from the wall outlet and consult qualified service personnel when:

- the power cord or the plug has been damaged.
- a solid object or liquid has fallen into the cabinet.

- the appliance has been exposed to rain or moisture.
- the appliance does not appear to operate normally or exhibits a marked change in performance.
- the appliance has been dropped, or the enclosure damaged.

Do not attempt to service the appliance beyond that described in the operating instructions. For all other servicing, refer to qualified service personnel **only**.

TABLE OF CONTENTS

Important Safeguards	i
BBE Process Explained	1-2
Product Description	2
Applications	2
Controls and Connections	3
Specifications	4
General Operation	4
Application Diagrams	5-9
Service /Warranty / Maintenance	10
Calibration Procedures	11
Schematic Diagrams.....	12-15

Congratulations on your purchase of the BBE 482 Sonic Maximizer—a two channel signal processor that will benefit any recording or sound reproduction system. You now own a very unique signal processing device with no equal in the audio world. Whether you purchased the BBE 482 for your home studio, P.A., DJ system, or instrument rack, you will find the 482's rugged construction and careful electronic design a welcome addition to your sonic arsenal.

Thank you for your purchase, and for the trust that you've placed in BBE. We are committed to bringing you the finest products, with useful and unique features to serve your audio needs.

The BBE Process—"What it Is"

Loudspeakers have difficulty working with the electronic signals supplied by an amplifier. These difficulties cause such major phase and amplitude distortion that the sound reproduced by speaker differs significantly from the sound produced by the original source.

In the past, these problems proved unsolvable and were thus delegated to a position of secondary importance in audio system design. However, phase and amplitude integrity is essential to accurate sound reproduction. Research shows that the information which the listener translates into the recognizable characteristics of a live performance are intimately tied into complex time and amplitude relationships between the fundamental and harmonic components of a given musical note or sound. These relationships define a sound's "sound".

When these complex relationships pass through a speaker, the proper order is lost. The higher frequencies are delayed. A lower frequency may reach the listener's ear first or perhaps simultaneously with that of a higher frequency. In some cases, the fundamental components may be so time-shifted that they reach the listener's ear ahead of some or all of the harmonic components.

This change in the phase and amplitude relationship on the harmonic and fundamental frequencies is technically called "envelope distortion." The listener perceives this loss of sound integrity in the reproduced sound as "muddy" and "smeared." In the extreme, it can become difficult to tell the difference between musical instruments, for example, an oboe and a clarinet.

BBE Sound, Inc. conducted extensive studies of numerous speaker systems over a ten year period. With this knowledge, it became possible to identify the characteristics of an ideal speaker and to distill the corrections necessary to return the fundamental and harmonic frequency structures to their correct order. While there are differences among various speaker designs in the magnitude of their correction, the overall pattern of correction needed is remarkably consistent.

The BBE Process is so unique that 42 patents have been awarded by the U.S. Patent Office.

Product Description

The BBE 482 is a dual channel, single rack space device for use in -10dBu line level applications. For each channel there are one pair of Lo Contour and Process knobs plus a 5 segment LED input level meter. A single function button switches the BBE process on or off in both channels, which is useful for comparing the processed sound to the unprocessed sound. An LED next to the function button glows green when the BBE process is on and red when the process is off. The Lo Contour controls are for adjusting the level of phase corrected low frequencies in the program material. The Process controls are for adjusting the level of phase corrected high frequencies in the program material.

Things to Remember

The BBE 482 is designed to work with -10dBu line levels. This is suitable for professional and semi-pro mixers, P.A. consoles, recording studios, or D.J. equipment. The BBE 482 drives load impedances down to 1K Ohm and supplies a maximum output level of +18dBu. Plugging a guitar or other high impedance device directly into the BBE 482 will not work properly as its input impedance is less than 50K ohms.

Set-Up

The BBE 482 is connected into the chain in series with the signal path the same way a graphic equalizer or limiter would be connected. The output of a mixer, pre-amp, or other sound source feeds the input of the BBE 482. Setting up the BBE 482 as an echo send device like a digital reverb is not recommended as the processed effect is not fully realized when summed with the original source audio.

WARNING! To prevent possible speaker or amplifier damage, always power-up peripheral devices first, wait 10 seconds, and then turn on the power amplifier. Turn off power amplifier first, then power-down peripheral devices.

APPLICATIONS

Music and P.A. Systems

The BBE 482 is a welcome addition to any live sound P.A. system because the BBE circuit dramatically improves the clarity and intelligibility of vocals and musical instruments. Night club and mobile DJ systems will also benefit greatly from the BBE Process, with more depth, detail and punch over the entire mix. The 482 can be hooked up to any P.A. or DJ sound system exactly like an equalizer would. When using in conjunction with an equalizer, the 482 should be added after the equalizer in the signal chain. In the event that the equalizer is being used for drastic tone alteration, then insert the 482 before the equalizer in the signal chain. Placement either before or after an equalizer should have no negative effect on the 482 unit or its processing ability, however most users find they prefer more modest use of their equalizers once the BBE 482 has been added to their sound systems.

Instrument Racks

The BBE 482 will deliver surprisingly good results in guitar, bass and keyboard rack systems. Electric guitars have added "bite", "chunk" and improved definition. As Guitar Player magazine said, "BBE is the most cost effective improvement you can add to your rig". Acoustic guitars processed with the 482 have a breathtakingly natural sparkle and presence. Bassists will delight in the BBE 482's ability to bring much more punch to the bottom end without muddying up the midrange. The 482 is also great for keyboard rigs, with everything from the latest samples to a vintage Rhodes benefiting equally from the patented BBE process.

Recording Systems

The BBE 482 can be used as an effect on individual tracks or applied overall during mixdown. The BBE process works very well to liven up the final mix, which is why the BBE 482 and 882 models are popular for use in both recreational and professional recording studios.

FRONT PANEL CONTROLS

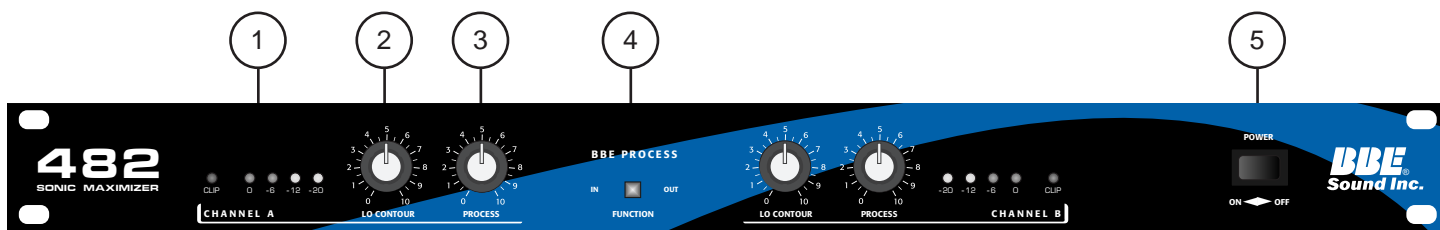

- 1. LED DISPLAY:** The LED display is used to indicate the output signal level of the BBE 482. Each number on the front panel corresponds to the output signal level, measured in decibels. Example: The “0” indicates a 0dBu signal level, “-6” refers to -6dBu, and so on. Once an input signal level has been established, increasing the BBE PROCESS and LO CONTOUR will increase the output signal and cause more LEDs to illuminate. The Clip LED monitors the input signal level. The Clip LED will illuminate at +15dBu, giving a 3dBu warning of the impending distortion at +18dBu, the actual clip point.
- 2. LO CONTOUR:** Regulates the amount of phase corrected bass frequencies.
- 3. PROCESS:** Regulates the amount of phase corrected treble frequencies.
- 4. BBE FUNCTION:** This push button switch allows for quick comparison of processed with unprocessed sound. When the switch is pushed in, the process is on and the indicator LED is green. When the switch is out, the process is off and the indicator LED is red.
- 5. POWER:** This switch controls primary power to the BBE 482.

REAR PANEL CONNECTIONS

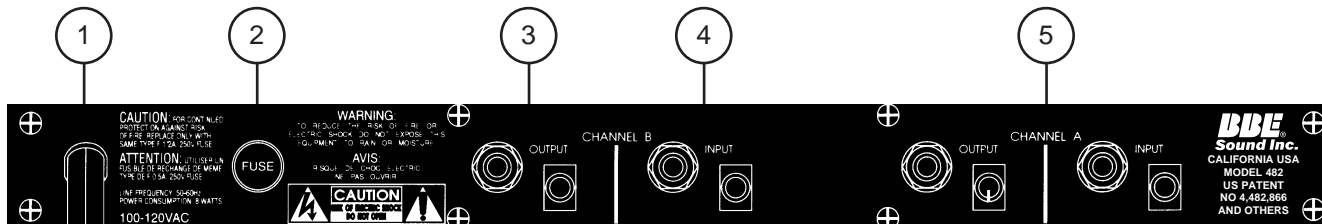

- 1. AC POWER CORD:** Plugs into AC power receptacle. U.S. Model, 100-120Vac, 50/60Hz. All other models, 220~240Vac, 50/60Hz.
- 2. FUSE:** Turn cap on fuse holder counter-clockwise to remove fuse. (Note: For U.S. Model, replace with 250Vac, 1/2A Fastblow type fuse. For all other models, replace with 250Vac, .125A Fastblow type fuse.)
- 3. OUTPUT:** The output of the BBE 482 can be taken from the 1/4” Phone Jack or the RCA Jack. Both are unbalanced and are the same point electronically. This allows both outputs to be used simultaneously, eliminating the need for a “Y” cord in the event multiple outputs are required. The recommended single load impedance is at least 10k Ohms. If both outputs are being used, a minimum of a 22k Ohm load per device is required. (The “load” is determined by the input impedance of the next subsequent component in the signal chain.) The maximum output is rated at +18dBu. The output impedance of the BBE 482 is 1 k ohms. NOTE: Actual output level will vary due to the selected position of the BBE Process, and the actual input signal level.
- 4. INPUT:** The input of the BBE 482 is an unbalanced connection. Although it can be either a 1/4” Phone Plug or an RCA Plug, it is recommended that only one input source is used. Both jacks are the same point electronically, however, due to the input/output impedance characteristics of most audio devices, a loss of signal may occur and/or damage to a component if both inputs are utilized. The input impedance of the BBE 482 is 47k Ohms. The maximum signal level is +18dBu.
- 5. CHANNEL A:** These connections function the same as CHANNEL B.

Specifications

Frequency Response,

process mode:.....Program controlled

bypass mode:10Hz to 50kHz +/-0.5dBu, -10dBu input

THD, process mode:.....less than 0.025% at -10dBu input, 20-20kHz

bypass mode:less than 0.002% at -10dBu input, 20-20kHz

Maximum Output:+18dBu (may vary due to control settings)

Input Impedance:47k Ohms, unbalanced 1/4" phone jack or RCA jack

Output Impedance:1 k Ohms, unbalanced 1/4" phone jack or RCA jack

Sensitivity:.....-45dBu for maximum process

Maximum Process:+12dBu boost at 5kHz, -10dBu input

Lo Contour:+12dBu boost at 50Hz, -10dBu input

* 0dBu = 0.775mVrms

Power Requirements:.....U.S., Canada 8 Japan models: 120VAC, 50/60Hz, 8 WATTS

Standard model: 220VAC, 50/60Hz, 8 WATTS

Fuse:Replace with the same type FASTBLOW fuse

U.S., Canada & Japan models: 250Vac, 1 /2A Fast blow type fuse.

Standard model: 250Vac, .125A Fastblow type fuse

Dimensions: 19"(W) x 5.5"(D) x 1.7"(H)

Shipping Weight:6.5 lbs.

Note: Due to continuing product improvement, specifications and design are subject to change without notice.

General Operation

THE BBE 482 IS A LINE LEVEL SIGNAL PROCESSOR AND IS TO BE CONNECTED PRIOR TO THE POWER AMP IN ANY AUDIO SYSTEM. SIGNIFICANT DAMAGE MAY BE INFLICTED TO THE BBE 482 OR ANY SUBSEQUENT COMPONENT IN THE SYSTEM IN THE EVENT THE OUTPUT OF A POWER AMP IS CONNECTED DIRECTLY TO THE INPUT OF THE BBE 482.

In order to reduce the risk of damage to any equipment, properly connect all cables and power cables before turning on any components in the system. Most important of all, **ALWAYS TURN ON THE POWER AMPLIFIER LAST TO AVOID DAMAGING THE SPEAKERS OR THE AMP.**

The BBE 482 may be utilized in a number of different environments and its results may vary accordingly. Because both channels are completely independent from each other, only one channel of the BBE 482 may be used, or each channel processing a different signal source. The effects loop is the ideal placement in the signal chain of a guitar application. In a pre-amp, keyboard or P.A. application, the BBE 482 works best as the last component in the signal chain, just before the crossover or power amp. Important: In a P.A. application, never connect the BBE 482 into the effects loop. The inherent phase shift of the BBE Process will cause phase cancellation resulting in a partial loss of signal.

BBE and Equalization

The most common question asked of the BBE Sound, Inc. service department is: "Where does the BBE Processor connect in the signal chain, before or after the equalizer?" Many people find that the same amount of equalization is no longer needed, if at all, when a BBE processor is used. Additionally, the amount of equalization used will help determine the BBE 482's proper location in the signal chain: If the EQ is being set to give the room a flat response as determined by a spectrum analyzer, the BBE 482 will work properly before or after the EQ. (Placing the BBE 482 after the EQ is recommended.) If the EQ is being used for drastic tone alteration, the recommended placement would be before the EQ. Neither of these configurations will harm the BBE 482.

LIVE APPLICATION: NON-POWERED MIXER

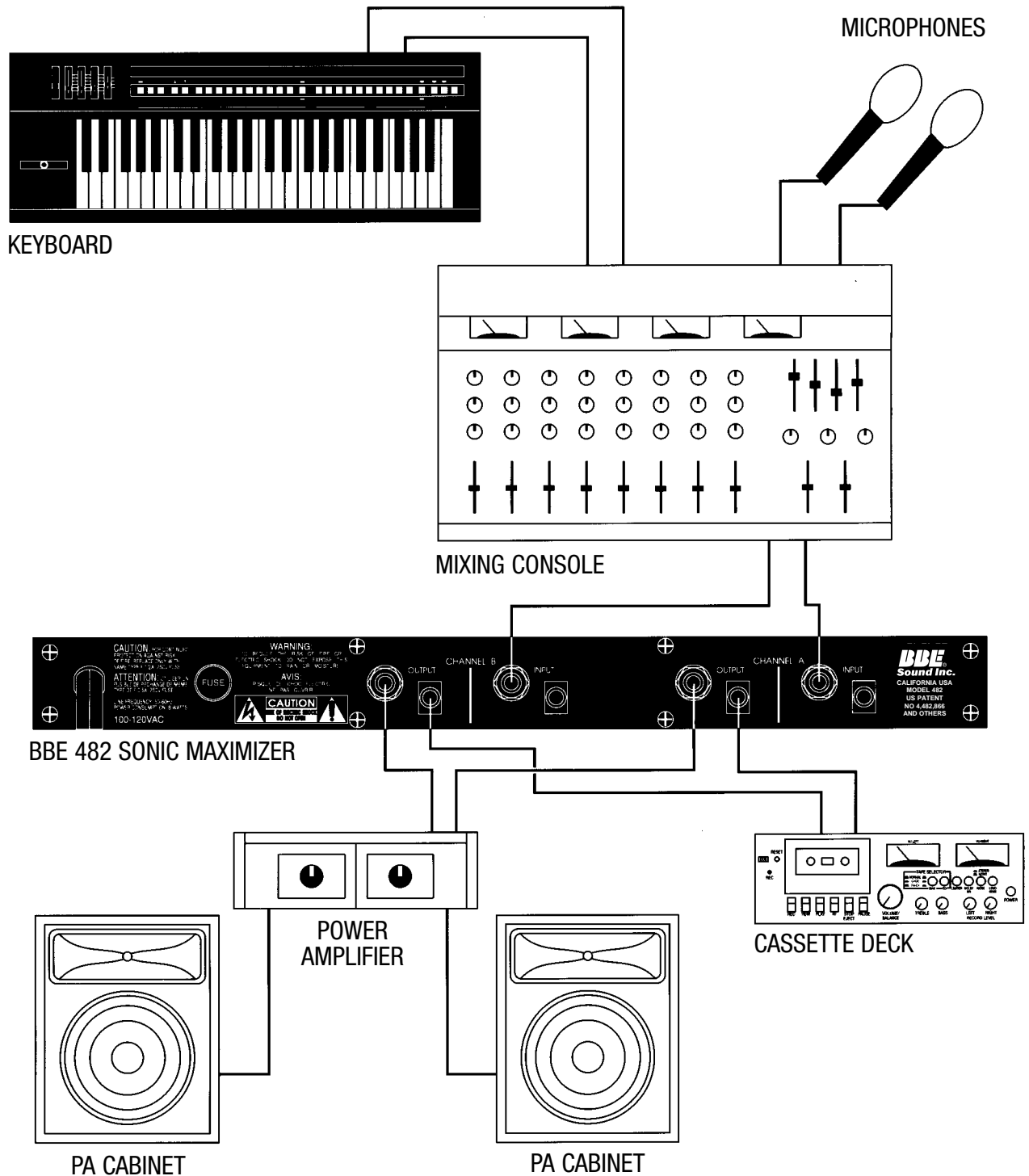

Connect the BBE 482 to the output of the mixing console. The output of the BBE will drive either a crossover or a power amplifier directly.

LIVE APPLICATION: POWERED MIXER

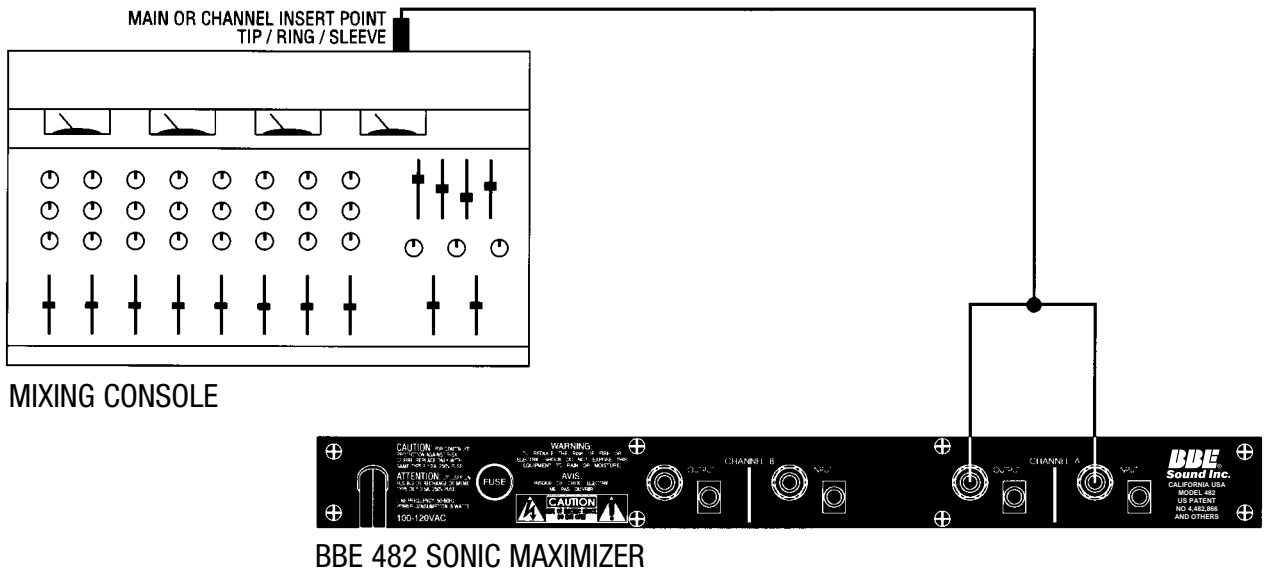
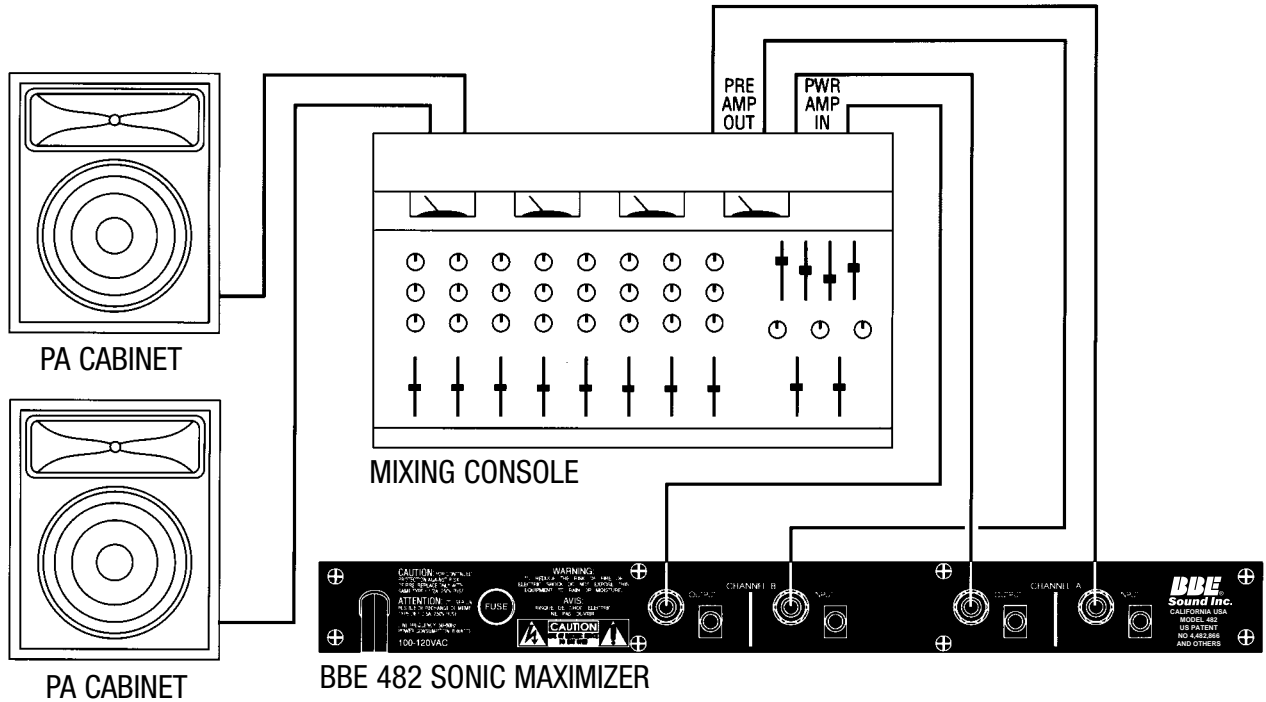

There are a couple of ways to configure the BBE 482 into a powered mixer. The ideal method would be into “Pre-Amp Out/Power Amp In” section of the console. If your console does not have this option, use the main or channel insert points.

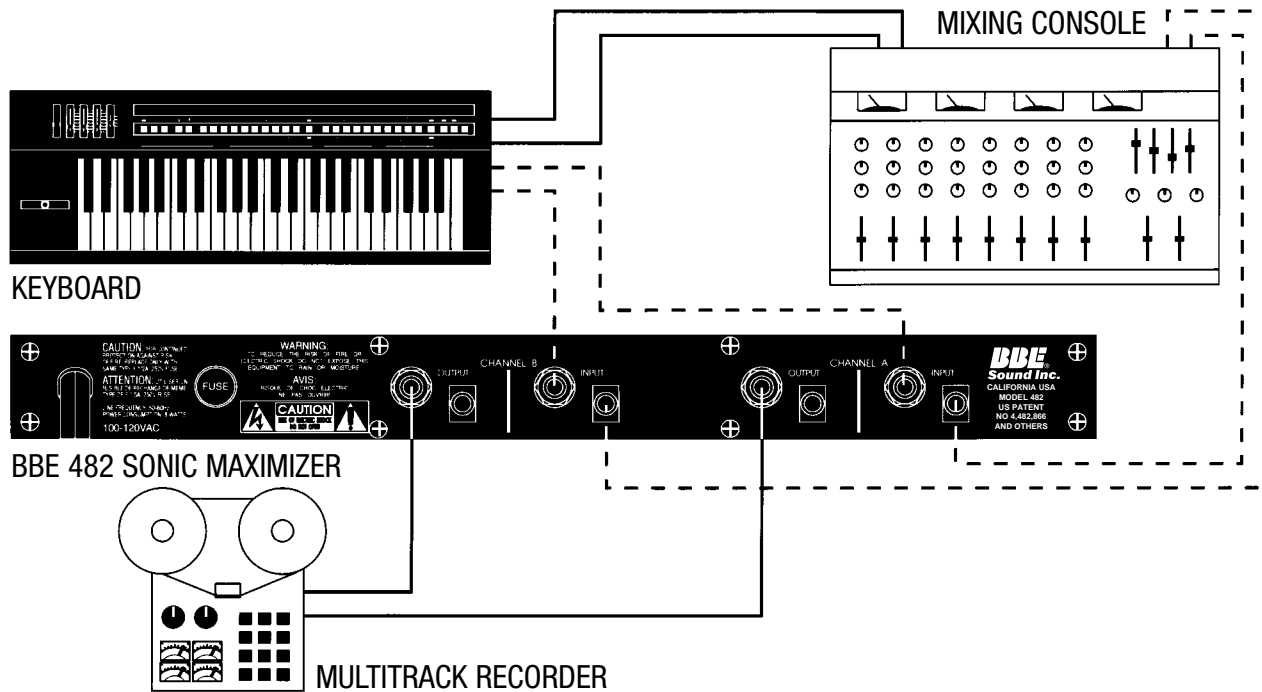

The BBE 482 can be utilized in the recording studio on individual instruments or on groups of instruments to improve the sound quality.

MASTERING OR DUBBING

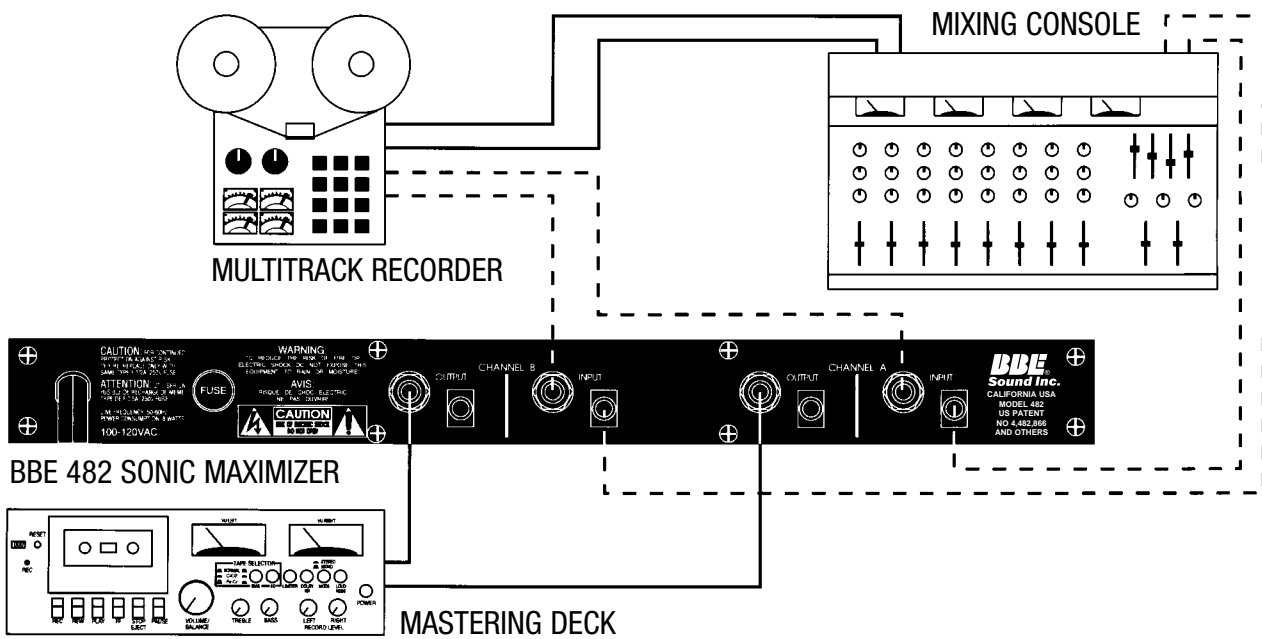

Use the BBE 482 for mastering the recording. Even if the BBE Process has been used on individual tracks, an improvement on the total mix will be noticed.

INDIVIDUAL INSTRUMENTS

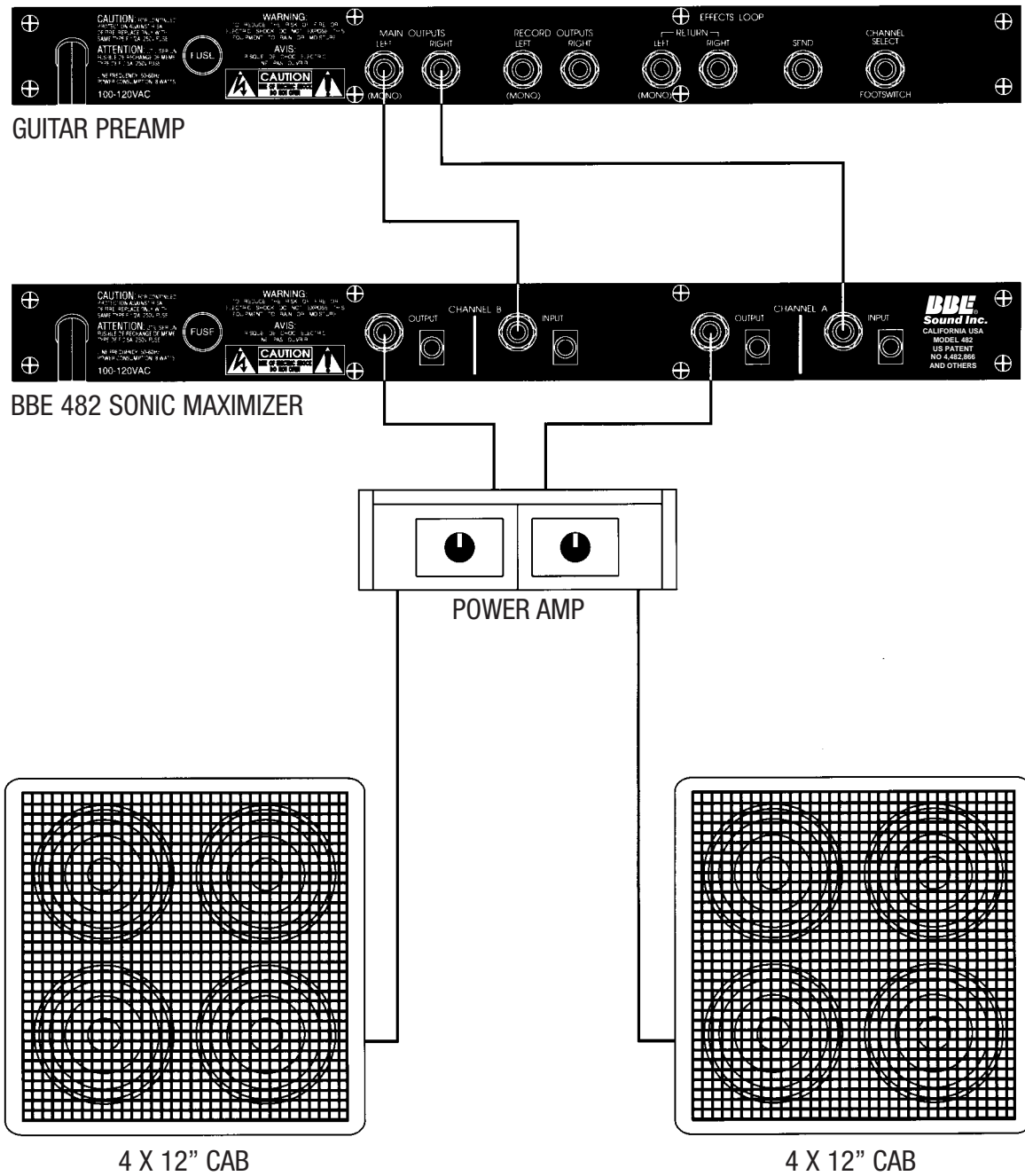

Use the BBE 482 in the effects loop or the main output of a guitar preamp. For keyboards, the output of the sub-mixer will be the ideal location.

SOUND CONTRACTORS

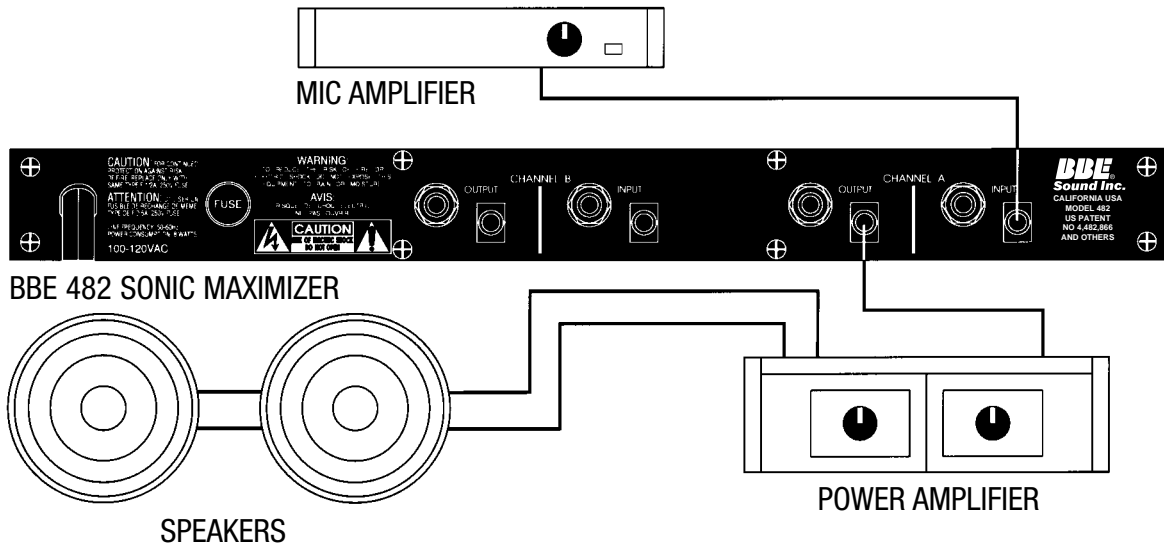

The BBE 482 will accept the output level of most sound contractor type mixers.

DJ APPLICATION

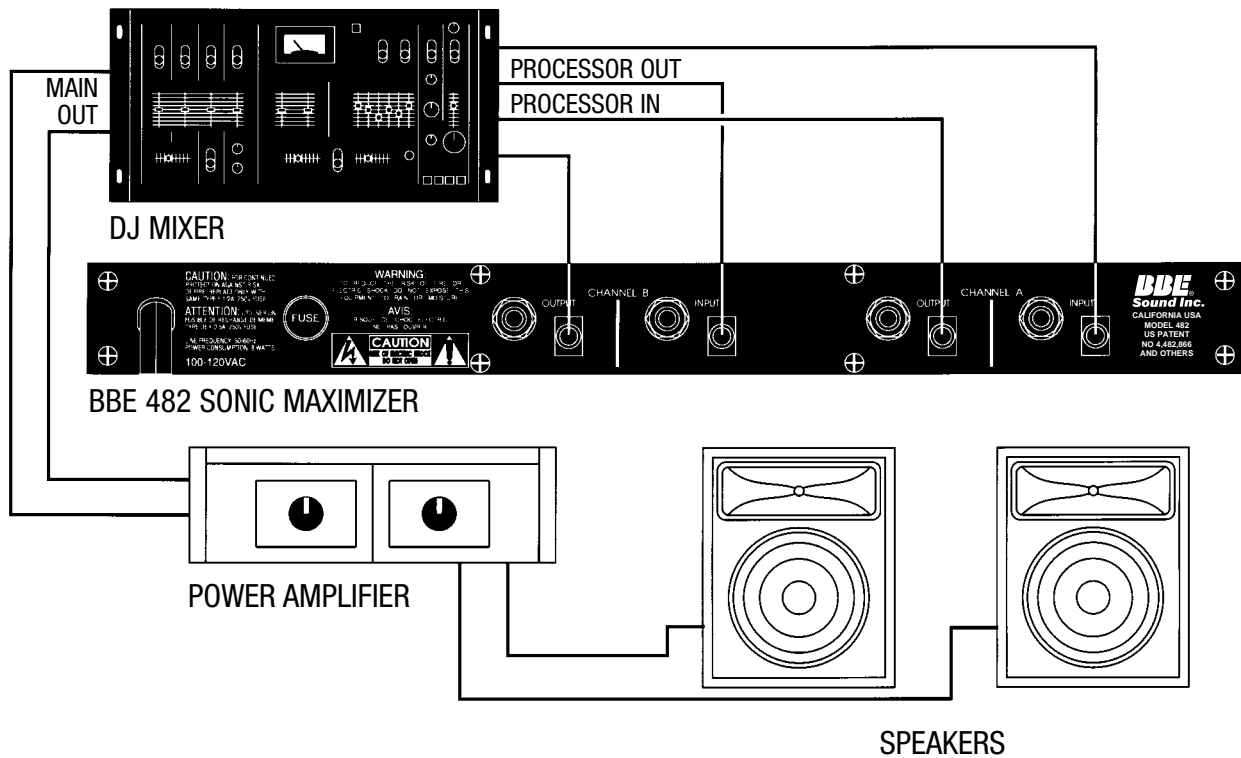

Connect the BBE 482 into the CAUTION loop of a pre-amplifier/mixer and hear the music come alive!

Service

We recommend that if at all possible, a BBE 482 which requires service be sent to our facility in Huntington Beach, California. We request that a "RETURN AUTHORIZATION" be issued by the dealer from whom you purchased the unit. If this is not possible, call BBE Sound, Inc. directly at (714) 897-6766, extension 116 to obtain a "RETURN AUTHORIZATION". Include a copy of the bill of sale with the unit when it is shipped to BBE Sound, Inc. so that the service can be expedited.

As the repair turnaround time is minimal, we request that the unit be sent to BBE Sound, Inc. We also need to add reliability data to our files so that future revision may be undertaken, if necessary, to improve the product. **If unit has been purchased outside the US, please contact your national distributor.**

Warranty

Warranty registration of the unit to BBE Sound, Inc. is not necessary. It is strongly recommended that you retain a copy of the bill of sale for future reference.

IT IS THE SOLE RESPONSIBILITY OF THE END USER TO PROVIDE THE BILL OF SALE OR OTHER MEANS OF PROOF OF PURCHASE TO VALIDATE THE WARRANTY IF WARRANTY SERVICE IS REQUESTED.

The BBE 482 is warranted against defects in material and workmanship for a period of five (5) years from date of purchase from BBE Sound Inc. or from an authorized dealer. During this period, we will repair units free of charge providing that they are shipped prepaid to BBE Sound, Inc., 5381 Production Drive, Huntington Beach, CA 92649. We will pay return UPS shipping charges within the USA. All charges related to non-UPS shipping, including customs clearance, will be billed. The warranty will be honored for the longer of either 90 days from the date of any service or the remainder of the original 5 Year factory warranty.

This warranty will be consider null and void by BBE Sound, Inc. if any of the following is found:

1. The equipment has been physically damaged.
2. The equipment shows signs of abuse.
3. The equipment has been electrically damaged by improper connection or attempted repair by the customer or a third party.
4. The equipment has been modified without authorization.
5. The bill of sales indicates that the purchase date of the equipment is not within the warranty period.

All non-warranty repairs are warranted for a period of 90 days from the date of service.

BBE Sound, Inc. is NOT LIABLE FOR CONSEQUENTIAL DAMAGES. Should the unit fail to operate for any reason, our sole obligation is to repair it as described above. **DO NOT RETURN ANY PRODUCT TO THE ABOVE ADDRESS WITHOUT INSTRUCTIONS AND AUTHORIZATION ISSUED BY THE ABOVE LOCATION.**

Maintenance

Maintenance of the BBE 482 is limited to proper cleaning of the unit with mild household cleaner such as Formula 409™ or Windex™. The chassis and cover are steel finished with a durable polyurethane paint, while the front panel is an anodized aluminum extrusion.

There are no user replaceable parts and the unit should not be opened for any reason unless you are a qualified technician. Calibration should be performed if parts are replaced or if a performance check-out indicates a problem with calibration. Long term use has shown that over the life of this unit there is little or no drift of the components in the BBE 482 which would cause a change in calibration. A very conservative design philosophy has resulted in a piece of equipment which runs very cool and should give years of trouble-free service.

Calibration Procedure for the BBE 482 (REVISION 1.1)

**NOTE: THIS UNIT WAS TESTED AND CALIBRATED AT THE FACTORY.
THIS PROCEDURE IS FOR QUALIFIED PERSONNEL ONLY.**

INITIAL SETTINGS:

1. BBE Process controls VR1 and VR3 to minimum.(C.C.W.)
2. Lo Contour controls VR2 and VR4 to minimum.(C.C.W.)
3. Power switch "ON" and BBE function switch "IN".

POWER SUPPLY TEST:

1. With DVM set to DC volts, measure the positive end of C27. You should read less than +30vdc.
2. With DVM set to DC volts, measure the negative end of C29. You should read less than -30vdc.
3. With DVM set to DC volts, measure the voltage on JMP5. Reading should be +15vdc, (+/-0.5vdc).
4. With DVM set to DC volts, measure the voltage on JMP4. Reading should be -15vdc, (+/-0.5vdc).

BBE PROCESS TEST:

1. Input a 5khz signal @ -10dBu into channel A [B] input.
2. With DVM set to AC volts, measure the channel A [B] output.
3. With Process control at minimum (C.C.W.) DVM should read -11.5dBu (+/-1dBu).
4. With Process control at maximum (C.W.) DVM should read +2dBu (+/-1dBu).

LO CONTOUR TEST:

1. Input a 50hz signal @ -10dBu into channel A [B] input.
2. With DVM set to AC volts, measure the channel A [B] output.
3. With Lo Contour control at minimum (C.C.W.) DVM should read -11dBu (+/-1dBu).
4. With Lo Contour control at maximum (C.W.) DVM should read +3dBu (+/-1dBu).

BYPASS TEST:

1. Input a 500hz signal @ -10dBu into channel A [B] input.
2. With DVM set to AC volts, measure the channel A [B] output.
3. With the process "IN", DVM should read -9dBu (+/-1dBu) and the Process "IN" LED should be on.
4. With the Process "OUT", DVM should read -11dBu (+/-1dBu) and the Process "OUT" LED should be on.

LED TEST:

1. Input a 5khz signal @ -20dBu into the channel A [B] input. The yellow -20 LED should light.
2. Change input level to -10dBu. The yellow -12dBu LED should light.
3. Change input level to -5dBu. The green -6dBu LED should light.
4. Change input level to 0dBu. The green 0 LED should light.
5. Change input level to +18dBu. The red clip LED should light.

END TEST.

**5381 Production Drive
Huntington Beach, CA 92649
(714) 897-6766**

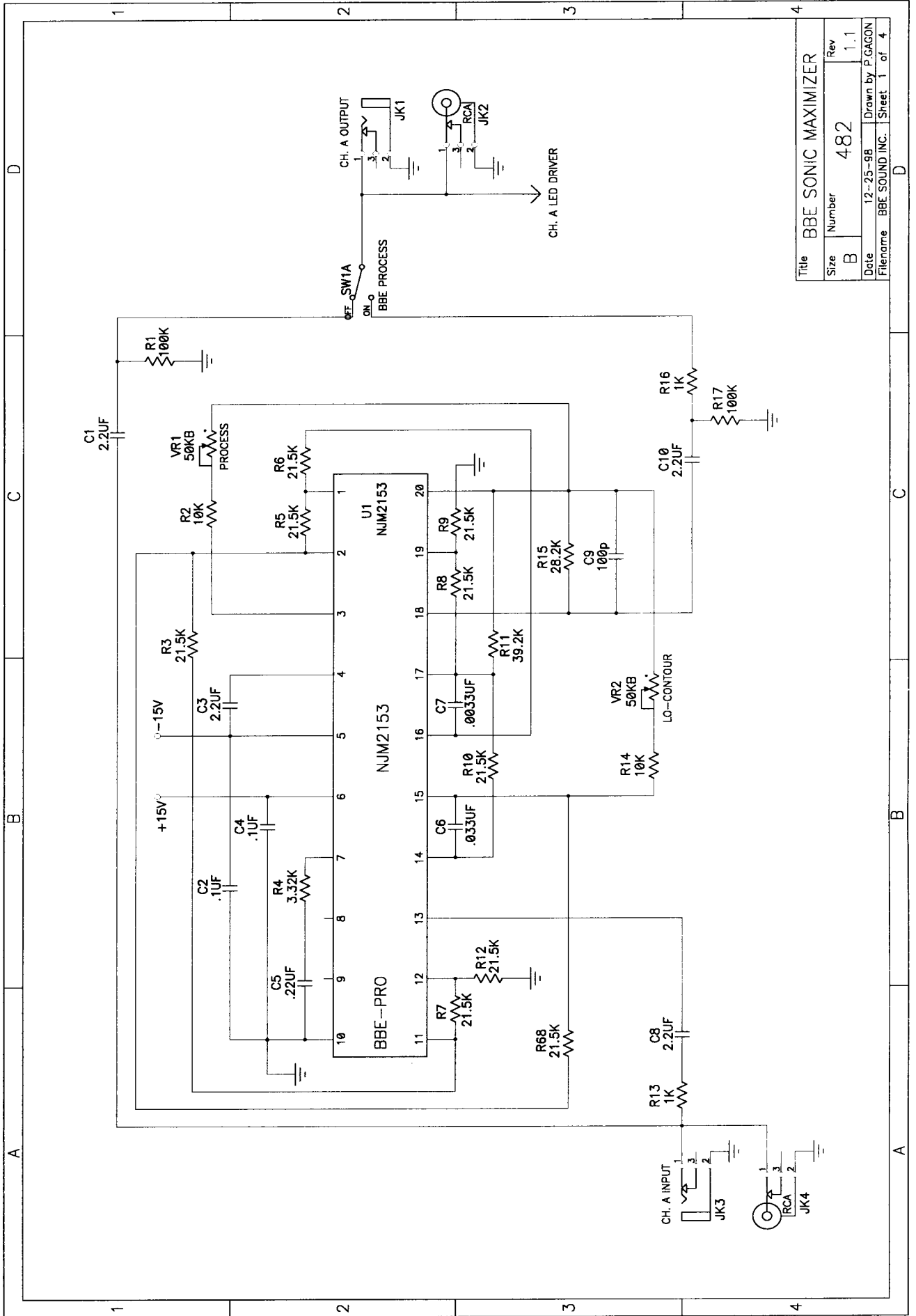

Title		BBE SONIC MAXIMIZER	
Size	Number	Rev	1.1
B	482		
Date	12-25-98		Drawn by P.GAGON
Filename		BBE SOUND INC.	Sheet 1 of 4

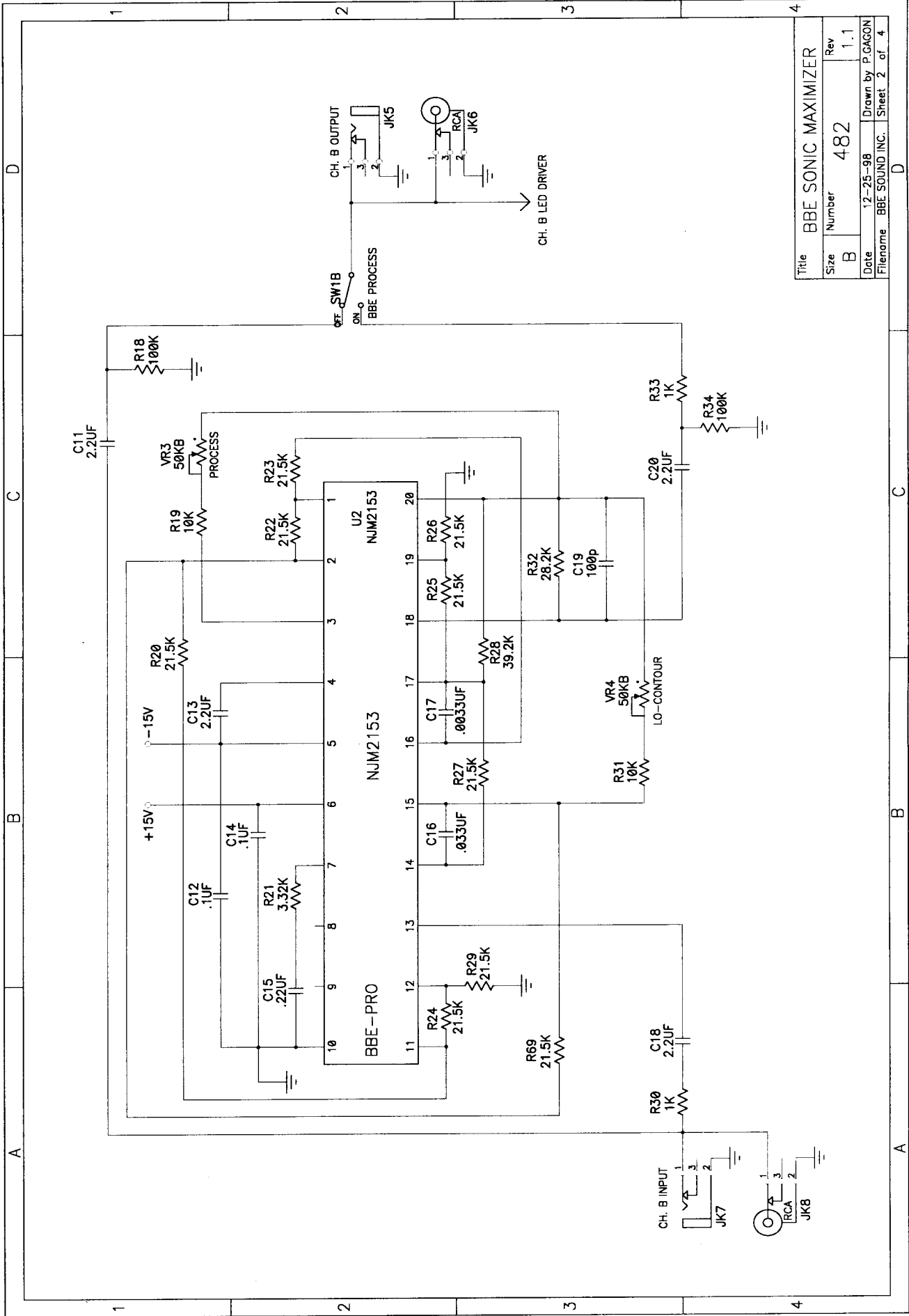

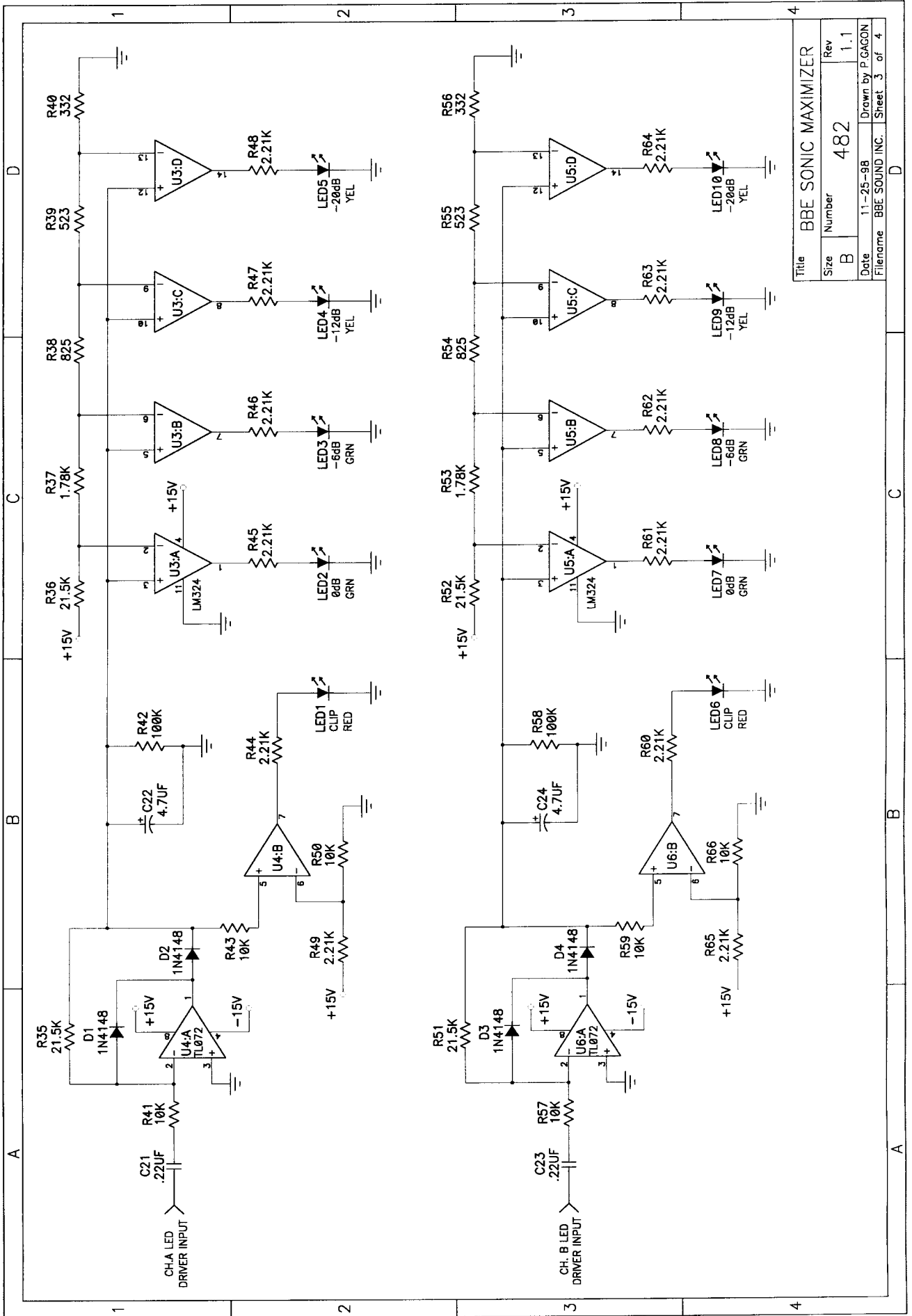

Title		BBE SONIC MAXIMIZER	
Size	Number	Rev	
B	482	1.1	
Date	11-25-98		Drawn by P.GAGON
Filename	BBE SOUND INC.		Sheet 3 of 4

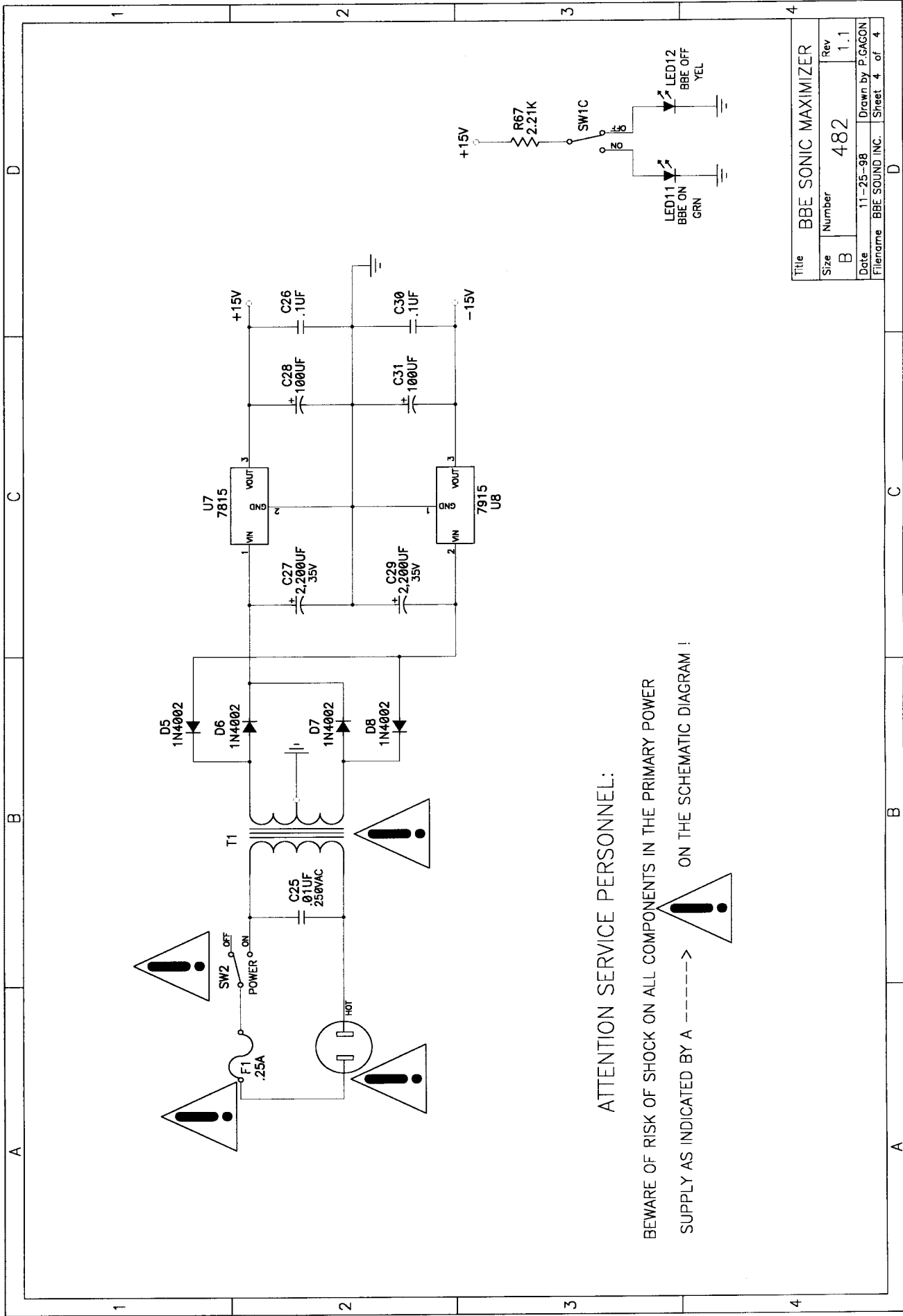

Title		BBE SONIC MAXIMIZER	
Size	Number	Rev	
B	482	1.1	
Date	11-25-98		Drawn by P.GAGON
Filename	BBE_SOUND_INC.		Sheet 4 of 4

ATTENTION SERVICE PERSONNEL:

BEWARE OF RISK OF SHOCK ON ALL COMPONENTS IN THE PRIMARY POWER SUPPLY AS INDICATED BY A ----->

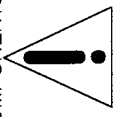

ON THE SCHEMATIC DIAGRAM !

NOTES:

NOTES:



BBE[®]
Sound Inc.

5381 Production Drive
Huntington Beach, CA 92649
714-897-6766 • FAX 714-896-0736

www.bbесound.com

covered by U.S. Patent 4,482,866 and other U.S. and foreign patents pending.
BBE is the registered trademark of BBE Sound, Inc.